

WOODWORKING TOOLS BY
BLACK&DECKER

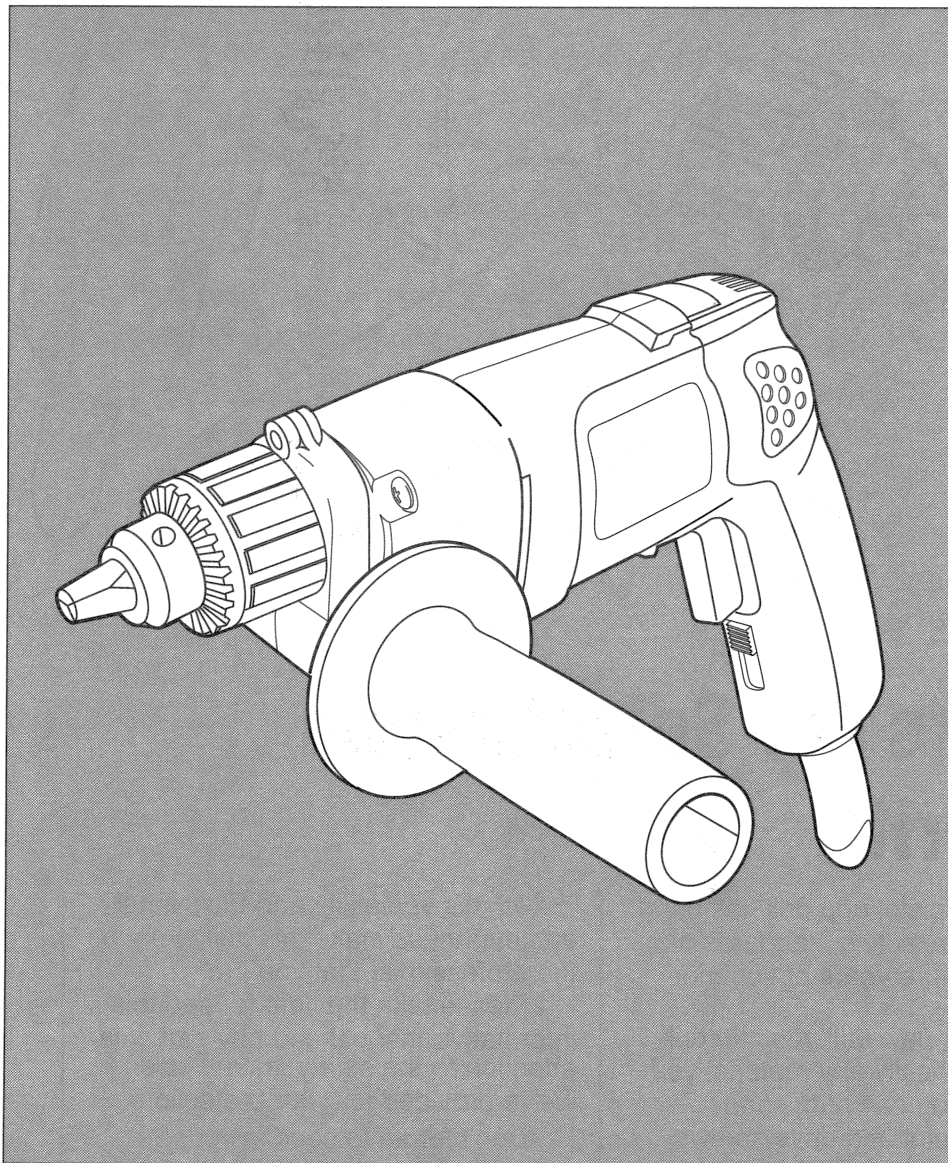

Instruction Manual

1186 & 1316 Pistol Grip Drills

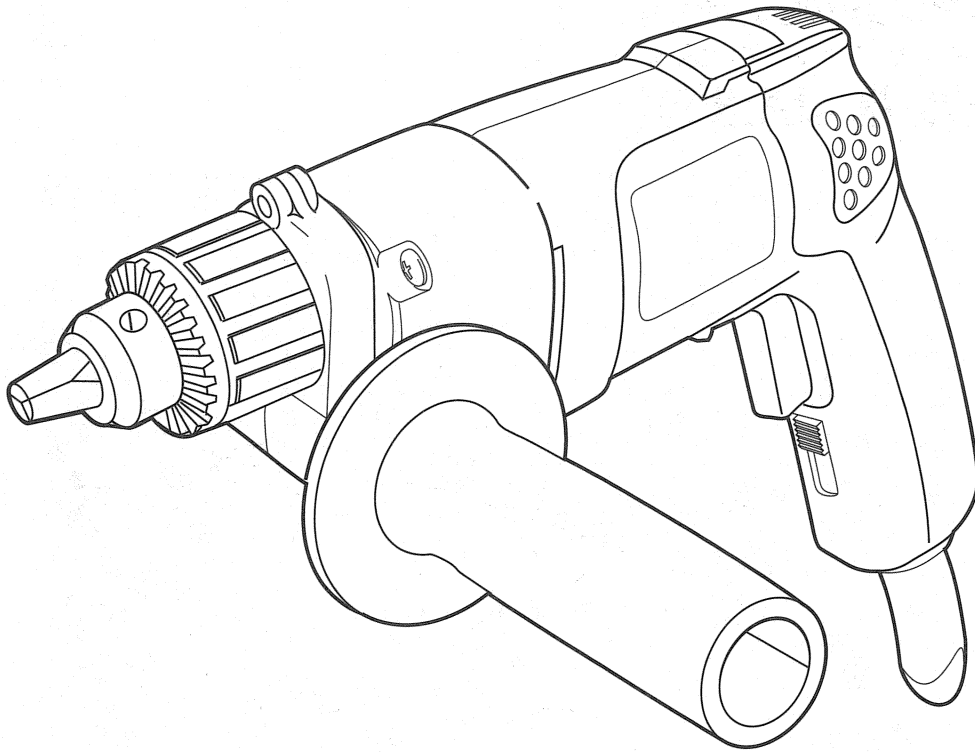

Thanks For Selecting an ELU Drill.

Your Elu pistol grip drill has been built to Elu's exacting standards of quality to ensure years of superior performance.

With your new drill you can drill holes in practically any material you can name. You can buff, sand, polish, mix paint and drive screws with features like variable speed and reversing capability.

All this versatility and Elu's inherent toughness make this drill every bit the professional that you are.

Please take the time to read this informative manual and pay particular attention to the safety instructions we've provided for your protection.

Don't forget to send in your owner's registration card.

THANKS AGAIN FOR BUYING
ELU!

EluTM
WOODWORKING TOOLS BY
BLACK&DECKER

Important Safety Instructions (For All Tools)

WARNING: When using Electric Tools, basic safety precautions should always be followed to reduce the risk of fire, electric shock, and personal injury, including the following:

READ ALL INSTRUCTIONS

1. **KEEP WORK AREA CLEAN.** Cluttered areas and benches invite injuries.
2. **CONSIDER WORK AREA ENVIRONMENT.** Don't expose power tools to rain. Don't use power tools in damp or wet locations. Keep work area well lit.
3. **GUARD AGAINST ELECTRIC SHOCK.** Prevent body contact with grounded surfaces. For example: pipes, radiators, ranges, refrigerator enclosures.
4. **KEEP CHILDREN AWAY.** All visitors should be kept away from work area. Do not let visitors contact tool or extension cord.
5. **STORE IDLE TOOLS.** When not in use, tools should be stored in dry, and high or locked-up place - out of reach of children.
6. **DON'T FORCE TOOL.** It will do the job better and safer at the rate for which it was intended.
7. **USE RIGHT TOOL.** Don't force small tool or attachment to do the job of a heavy-duty tool. Don't use tool for purpose not intended, for example, don't use circular saw for cutting tree limbs or logs.
8. **DRESS PROPERLY.** Do not wear loose clothing or jewelry. They can be caught in moving parts. Rubber gloves and non-skid footwear are recommended when working outdoors. Wear protective hair covering to contain long hair.
9. **USE SAFETY GLASSES.** Also use face or dustmask if cutting operation is dusty.
10. **DON'T ABUSE CORD.** Never carry tool by cord or yank it to disconnect from receptacle. Keep cord from heat, oil, and sharp edges.
11. **SECURE WORK.** Use clamps or a vise to hold work. It's safer than using your hand and it frees both hands to operate tool.
12. **DON'T OVERREACH.** Keep proper footing and balance at all times.
13. **MAINTAIN TOOLS WITH CARE.** Keep tools sharp and clean for better and safe performance. Follow instructions for lubricating and changing accessories. Inspect tool cords periodically and if damaged have repaired by authorized service facility. Inspect extension cords periodically and replace if damaged. Keep handles dry, clean, and free from oil and grease.
14. **DISCONNECT TOOLS.** When not in use, before servicing, and when changing accessories, such as blades, bits, cutters.
15. **REMOVE ADJUSTING KEYS AND WRENCHES.** Form habit of checking to see that keys and adjusting wrenches are removed from tool before turning it on.
16. **AVOID UNINTENTIONAL STARTING.** Don't carry plugged-in tool with finger on switch. Be sure switch is off when plugging in.
17. **OUTDOOR USE EXTENSION CORDS.** When tool is used outdoors, use only extension cords intended for use outdoors and so marked. More detailed extension cord information can be found on page 8.
18. **STAY ALERT.** Watch what you are doing. Use common sense. Do not operate tool when you are tired.
19. **CHECK DAMAGED PARTS.** Before further use of the tool, a guard or other part that is damaged should be carefully checked to determine that it will operate properly and perform its intended function. Check for alignment of moving parts, binding of moving parts, breakage of parts, mounting, and any other conditions that may affect its operation. A guard or other part that is defective should be properly repaired or replaced by an authorized service center unless otherwise indicated elsewhere in this instruction manual. Have defective switches replaced by authorized service center. Do not use tool if switch does not turn it on and off.
20. **DO NOT OPERATE** portable electric tools near flammable liquids or in gaseous or explosive atmospheres. Motors in these tools normally spark, and the sparks might ignite fumes.

CAUTION: When drilling into walls, floors or wherever "live" electrical wires may be encountered, DO NOT TOUCH THE CHUCK OR ANY FRONT METAL PARTS OF THE DRILL! Hold the Drill only by the plastic handle to prevent shock if you drill into a "live" wire.

SAVE THESE INSTRUCTIONS

Double Insulation

DOUBLE-INSULATED tools are constructed throughout with TWO separate "layers" of electrical insulation or one DOUBLE thickness of insulation between you and the tool's electrical system.

Tools built with this insulation system are not intended to be grounded. As a result, your tool is equipped with a two-prong plug which permits you to use extension cords without concern for maintaining a ground connection. See page 8 for more extension cord information.

NOTE: DOUBLE-INSULATION does not take the place of normal safety precautions when operating this tool. The insulation system is for added protection against injury resulting from a possible electrical failure within the tool.

CAUTION: When servicing all tools, USE IDENTICAL REPLACEMENT PARTS. Repair or replace damaged cords.

Motor Brushes

Your Drill uses the "Checkpoint" brush system. The tool will stop when the brushes wear out. This prevents damage to the motor.

Switches

To start Drill, depress trigger switch; to stop Drill, release trigger. To lock trigger in "ON" position for continuous operation, depress trigger and push up locking button "A" Figure 1, then gently release trigger. To release locking mechanism, depress trigger fully, then release it. Before using the tool (each time) be sure that the locking button release mechanism is working freely.

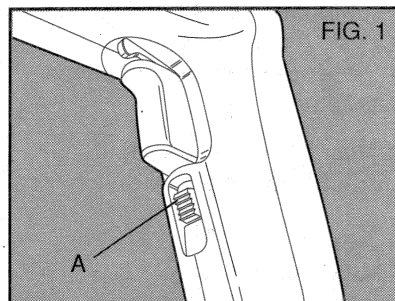

Do not lock the switch "ON" when drilling by hand so that you can instantly release the trigger switch if the bit binds in the hole.

The locking button is for use only when the drill is mounted in a drill press stand or otherwise held stationary.

Be sure to release the locking button before disconnecting the plug from the power supply. Failure to do so will cause the tool to start immediately the next time it is plugged in. Damage or injury could result.

The Variable Speed Trigger Switch permits speed control—the farther the trigger is depressed, the higher the speed of the Drill. **NOTE:** Use lower speeds for starting holes without a center punch, drilling in metal or plastics, driving screws, drilling ceramics, or mixing paint. Higher speeds are better for drilling wood and composition boards, and for using abrasive and polishing accessories.

The Reversing Lever is used for withdrawing bits from tight holes and removing screws at lower speeds. It is located above the trigger switch (Fig. 2). To reverse the motor, release the trigger FIRST and then push the lever to the right. After any reversing operations, return lever to forward position.

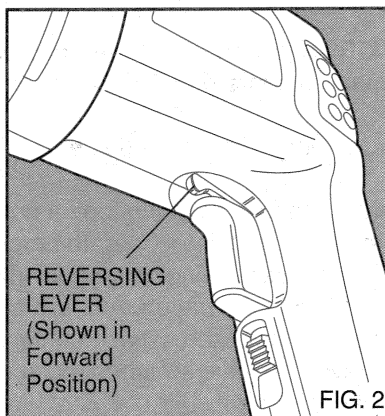

Operation

DRILLING

1. Always unplug the Drill when attaching or changing bits or accessories.
2. Use sharp drill bit only. For WOOD, use twist drill bits,

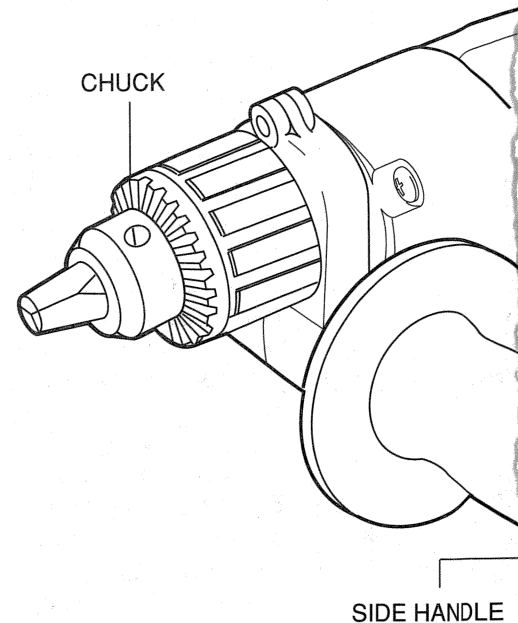

spade bits, power auger bits, or hole saws. For METAL, use highspeed steel twist drill bits or hole saws. For MASONRY, such as brick, cement, cinder block, etc., use carbide-tipped bits.

3. Be sure the material to be drilled is anchored or clamped firmly. If drilling thin material, use a wood "back-up" block to prevent damage to the material.
4. Always apply pressure in a straight line with the bit. Use enough pressure to keep drill biting, but do not push hard enough to stall the motor or deflect the bit.
5. Hold drill firmly to control the twisting action of the drill.
6. IF DRILL STALLS, it is usually because it is being overloaded or improperly used. RELEASE TRIGGER IMMEDIATELY, remove drill bit from work, and determine cause of stalling. DO NOT CLICK TRIGGER OFF AND ON IN AN ATTEMPT TO START A STALLED DRILL—THIS CAN DAMAGE THE DRILL.
7. To minimize stalling or breaking through the material, reduce pressure on drill and ease the

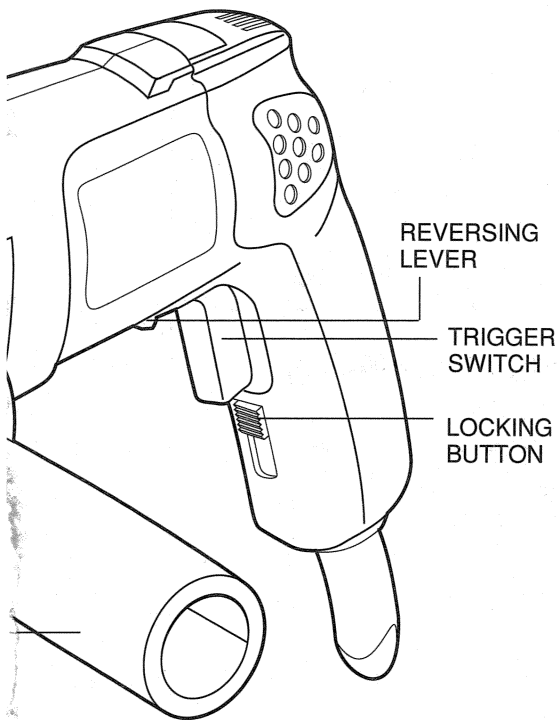

- bit through the last fractional part of the hole.
- Keep the motor running when pulling the bit back out of a drilled hole. This will help prevent jamming.
 - With Variable Speed Drills there is no need to center punch the point to be drilled. Use a slow speed to start the hole and accelerate by squeezing the trigger harder when the hole is deep enough to drill without the bit skipping out.

Chuck

Open chuck jaws by turning collar with fingers and insert shank of bit about 3/4" into chuck. Tighten chuck collar by hand. Place chuck key in each of the three holes, and tighten in clockwise direction. It's important to tighten chuck with all three holes to prevent bit slippage. To release bit, turn chuck key counter clockwise in just one hole, then loosen the chuck by hand.

Drilling In Metal

Use a cutting lubricant when drilling metals. The exceptions are cast iron and brass which should be drilled dry. The cutting lubricants that work best are sulphurized cutting oil or lard oil; bacon-grease will also serve the purpose.

Drilling In Wood

Holes in wood can be made with the same twist drills used for metal. These bits may overheat unless pulled out frequently to clear chips from the flutes. For larger holes, use Power Drill Wood Bits. Work that is apt to splinter should be backed up with a block of wood.

Drilling In Masonry

Use carbide tipped masonry bits at low speeds. Keep even force on the drill but not so much that you crack the brittle materials. A smooth, even flow of dust indicates the proper drilling rate.

Side Handle

CAUTION: Always use side handle when provided and hold Drill with both hands.

The side handle clamps to the front of the gear case as shown in Figure 3 and can be rotated 360 degrees to permit right or left hand use.

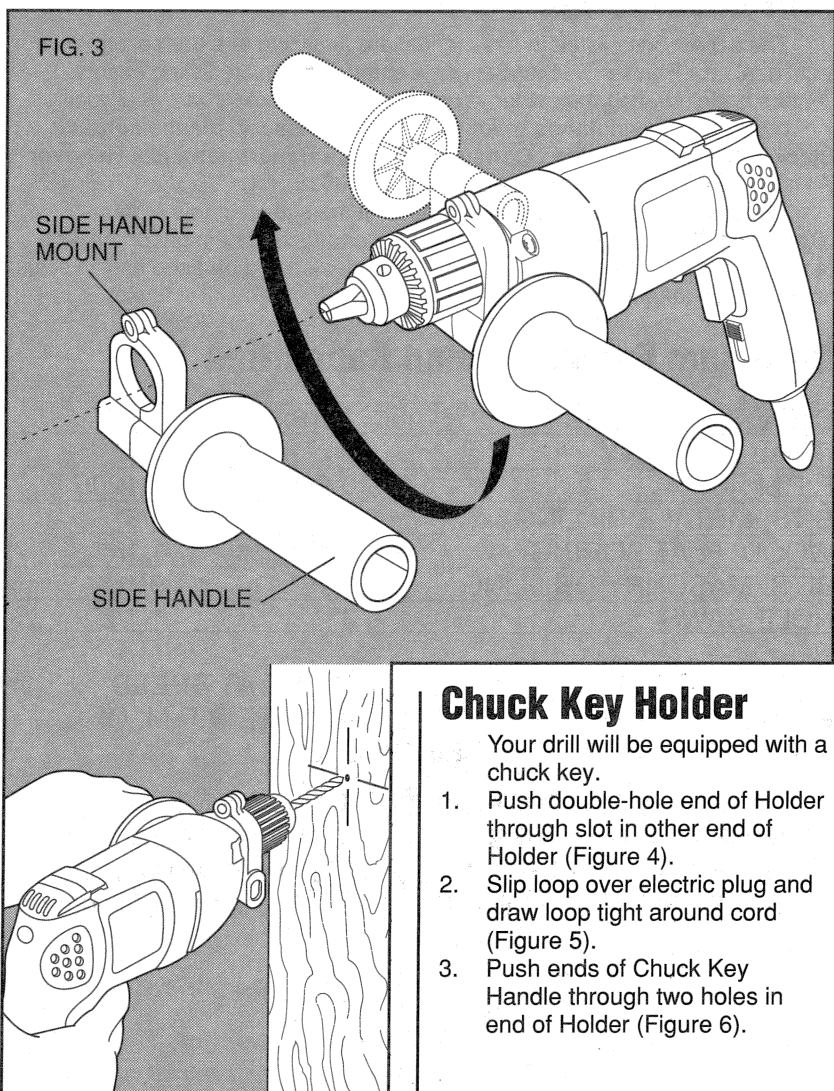

Chuck Key Holder

Your drill will be equipped with a chuck key.

- Push double-hole end of Holder through slot in other end of Holder (Figure 4).
- Slip loop over electric plug and draw loop tight around cord (Figure 5).
- Push ends of Chuck Key Handle through two holes in end of Holder (Figure 6).

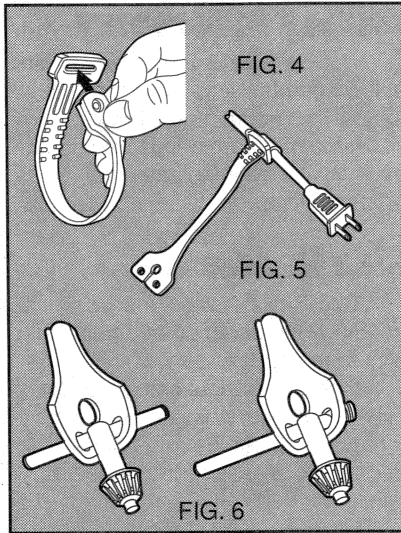

Chuck Removal

(Figures 7 & 8)

Place chuck key in chuck as shown in Fig. 7. Using a wooden mallet or similar object, strike key sharply in a **CLOCKWISE** direction. This will loosen screw inside chuck.

Open chuck jaws fully. Insert screwdriver (or 3/16" hex wrench if required) into front of chuck between jaws to engage screw. Remove by turning clockwise (left-hand-thread).

Place key in chuck as shown in Fig. 8. Using a wooden mallet or similar object, strike key sharply in a **COUNTER-CLOCKWISE** direction. This will loosen chuck so that it can be unscrewed by hand.

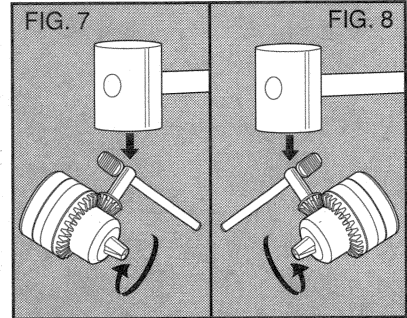

Drill Accessories

The accessories listed in this manual are available at extra cost from your local dealer or Black & Decker Service Center. A complete listing of service centers is included on the owner's registration card packed with your tool.

If you need assistance in locating any accessory, please contact: Black & Decker (U.S.) Inc., Consumer Service Department, 626 Hanover Pike, P. O. Box 618, Hampstead, MD 21074-0618.

Recommended accessories for your Drill are shown in this manual (CAUTION: The use of any other accessory or attachment might be hazardous.) For safety in use, the following accessories should be used only in sizes up to the maximums shown in the table below.

Maximum Recommended Capacities

CATALOG NUMBER	1316	1186
DRILL CAPACITY	1/2"	3/8"
R.P.M.	0-900	0-1200
BITS, METAL DRILLING	1/2"	3/8"
WOOD, FLAT BORING	1 1/2"	1 1/4"
BITS, MASONRY DRILLING	9/16"	9/16"
HOLE SAWS	3"	1 1/2"

ACCESSORY MUST BE RATED FOR USE AT SPEED EQUAL TO OR HIGHER THAN NAMEPLATE R.P.M. OF TOOL WITH WHICH IT IS BEING USED.

WIRE WHEEL BRUSHES	4" Diameter Maximum
WIRE CUP BRUSHES	3" Diameter Maximum
BUFFING WHEELS	3" Diameter Maximum
RUBBER BACKING PADS	4 5/8" Diameter Maximum

Carbon Removing Brushes

Made of tempered-steel wire; used with drills to remove rust and scale from metals. Leaves a burnished surface.

- Heavy-duty solid wire-filled brush.
- Side-flare brush for close corner work.
- Hollow-core, flare-bottom brush. Small cleaning brush. (Not Shown.)

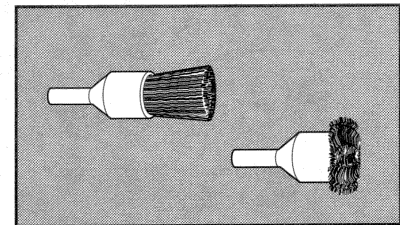

3" Wire Cup Brush

Use in cleaning and removing rust, scale, old paint (Straight chuck shank). Maximum safe RPM—5,000.

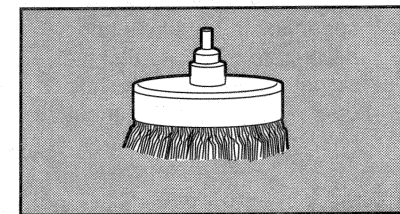

Heavy-Duty Tool Box

13" x 8-1/2" x 6-3/4"

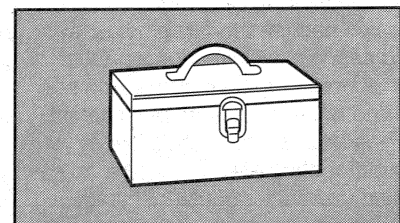

Drill Stop

Capacity 1/4" to 1/2" Governs drilling depth. Drill Stop.

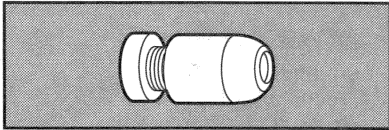

Wheel Arbors

Fit 1/4" to 1/2" Drills. Carry wire wheel brushes and buffing wheels. 1/4" Arbor (1/2" dia., 1/4" shank). 1/2" Arbor (1/2" dia., 1/2" shank).

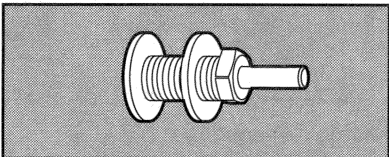

Buffing Wheels

Use with 1/4" to 1/2" Drills and Wheel Arbors. 3" x 3/8" x 1/2" Cotton Buff.

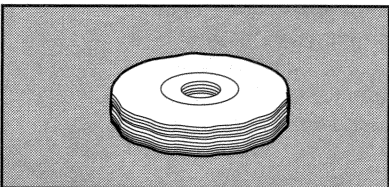

Rubber Backing Pad

Fit 1/4" to 1/2" Drills. 4 5/8" Rubber Backing Pad with plain shank. Used for sanding operations.

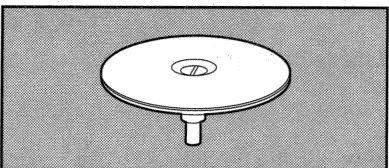

Wire Wheel Brushes

Use in cleaning and removing rust, scale, old paint. 4" Fine Brush, crimped; Maximum safe RPM - 4,500. 4" Coarse Brush, crimped; Maximum safe RPM - 4,500.

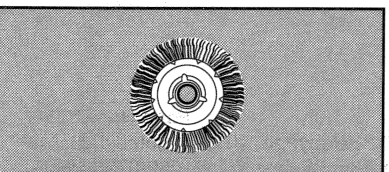

Sanding Discs

Use with Rubber Backing Pad.

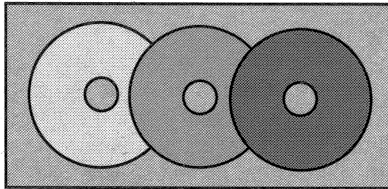

High-Speed Hole Saws Use With Mandrels

SAW OUTSIDE DIAMETER	FOR CONDUIT SIZES	FOR PIPE TAP SIZES
5/8"	5/8" Hole Saw has built-in Mandrel; no separate Mandrel supplied	
3/4"	3/8"	
7/8"	1/2"	
15/16"		3/4"
1"		
11/16"		
1 1/8"	3/4"	
13/16"		1"
1 1/4"		
1 3/8"	1"	
1 1/2"		1 1/4"
1 5/8"		
1 3/4"	1 1/4"	1 1/2"
1 7/8"		
2"	1 1/2"	
21/16"		
2 1/8"		
2 1/4"		
2 3/8"		
2 1/2"	2"	
2 5/8"		
2 3/4"		
2 7/8"		
3"	2 1/2"	

Round-Shank Masonry Bits

These bits are carbide-tipped for top performance and extra-long life in most masonry-drilling applications.

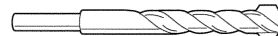

BIT DIAMETER (IN.)	USABLE DRILLING DEPTH (IN.)	SHANK DIAMETER (IN.)
3/16"	1 1/2"	3/16"
1/4"	2"	1/4"
5/16"	2 1/4"	1/4"
3/8"	2 1/2"	1/4"
1/2"	2 1/2"	1/4"
9/16"	4 1/4"	1/4"

Extension Cords

Double insulated tools have 2-wire cords and can be used with 2-wire or 3-wire extension cords. Only round jacketed extension cords should be used, and we recommend that they be listed by Underwriters Laboratories (U.L.) (C.S.A. in Canada). If the extension will be used outside, the cord must be suitable for outdoor use. Any cord marked as outdoor can also be used for indoor work. The letters "WA" on the cord jacket indicate that the cord is suitable for outdoor use.

An extension cord must have adequate wire size (AWG or American Wire Gauge) for safety, and to prevent loss of power and overheating. The smaller the gauge number of the wire, the greater the capacity of the cable, that is 15 gauge has more capacity than 18 gauge. When using more than one extension to make up the total length, be sure each individual extension contains at least the minimum wire size.

To determine the minimum wire size required, refer to the chart below.

CHART FOR MINIMUM WIRE SIZE (AWG) OF EXTENSION CORDS								
NAMEPLATE RATING-AMPS	TOTAL EXTENSION CORD LENGTH-FEET							
	25	50	75	100	125	150	175	200
0 - 10.0	18	18	16	16	14	14	12	12
10.1 - 13.0	16	16	14	14	14	12	12	12
13.1 - 15.0	14	14	12	12	12	12	12	---

Before using an extension cord, inspect it for loose or exposed wires, damaged insulation, and defective fittings. Make any needed repairs or replace the cord if necessary. Black & Decker has extension cords available that are U.L. (C.S.A. in Canada) listed for outdoor use.

Lubrication

All ball and sleeve bearings used are factory lubricated to last the life of the bearings. All needle bearings used receive their lubrication from the grease in the gear case. Clean and re-lubricate gear case yearly or whenever servicing requires the gear case to be removed. Use type and quantity of grease shown on Parts bulletin packed with your tool.

Gear case is removed by removing the three screws from the front of the tool. If the chuck is too large to permit removal of the two top screws, see instructions for chuck removal.

Warranty

Elu warrants this product for one year from date of purchase. We will repair without charge, any defects due to faulty material or workmanship. Please return the complete unit, transportation prepaid, to any Black & Decker Service Center or authorized Service Station listed under "Tools Electric" in the yellow pages. This warranty does not apply to accessories or damage caused where repairs have been made or attempted by others.

Like most Black & Decker products your tool is listed by Underwriter's Laboratories to ensure that it meets stringent safety requirements.



This symbol on the nameplate means the product is listed by Underwriter's Laboratories, Inc.

See 'Tools-Electric'
—Yellow Pages—
for Service & Sales

