

 **BLACK &
DECKER**®

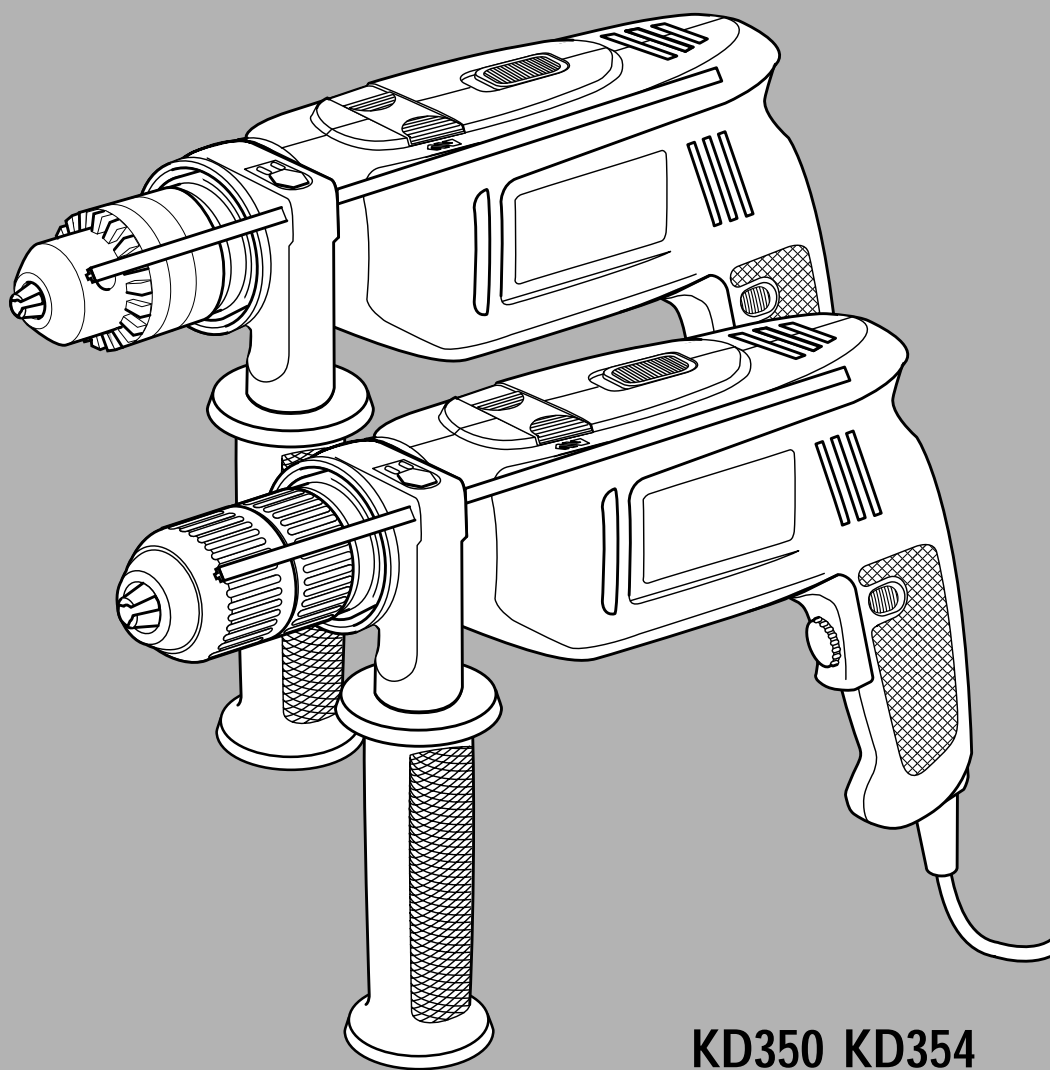

**KD350 KD354
KD351 KD355
KD352 KD356
KD353 KD455**

Congratulations!

On the purchase of your Black & Decker corded drill.

To ensure the best results from your corded drill please read these safety and usage instructions carefully. If you have any questions or queries after reading this manual please do not hesitate to call your local service and information centre (the number is towards the back of this manual).

Contents

- Page 4* Safety instructions
 - Double insulation
- Page 5* Electrical safety
 - Mains plug replacement
 - Extension cables
 - Unwanted tools and the environment
 - The Black & Decker guarantee
- Page 6* After sales service for your Black & Decker product
 - Our after sales service policy
 - Accessories
 - Technical data
 - Features
 - Fitting the drill bit
- Page 7* Removing the chuck
 - Fitting the side handle
 - Setting the adjustable depth stop
 - Preparing your drill for operation
- Page 8* Using your drill
 - Handy hints
 - Cooling down
 - Overload
 - EC declaration of conformity
 - Black & Decker phone numbers and addresses
 - Guarantee card

Corded drills user manual

SAFETY INSTRUCTIONS

Warning! When using electric tools, the following basic safety precautions should always be taken to reduce the risk of fire, electric shock and personal injury. Read all these instructions before attempting to operate the product and save this booklet.

For safe operation:

- **Keep the work area clean.** Cluttered areas and benches invite injuries.
- **Consider the work area environment.** Do not expose the power tool to rain and do not use in damp or wet locations. Keep the work area well lit. Do not use the power tool where there is a risk to cause fire or explosion.
- **Guard against electric shock.** Avoid body contact, where possible, with earthed or grounded surfaces (e.g. pipes, radiators, ranges and refrigerators).
- **Keep children away.** Do not let visitors touch the tool or extension cord. All visitors should be kept away from the work area.
- **Store idle tools.** When not in use, tools should be stored in a dry, high or locked place, out of reach of children.
- **Do not force the tool.** It will do the job better and more safely at the rate for which it was intended.
- **Use the right tool.** Do not force small tools or attachments to do the job of a heavy duty tool. Do not use the tool for purposes not intended; for example, do not use a circular saw to cut tree limbs or logs.
- **Dress properly.** Do not wear loose clothing or jewellery as they can be caught in moving parts. Rubber gloves and non-skid footwear are recommended when working outdoors. Wear protective hair covering to contain long hair.
- **Use safety glasses.** Use a face or dust mask as well, if the operation is dusty or if the tool is being used in enclosed spaces.
- **Connecting dust extraction equipment.** If devices are provided for the connection of dust extraction and collection ensure these are connected and properly used, especially in confined areas.
- **Do not abuse the cord.** Never carry the tool by its cord or yank it to disconnect it from the socket. Keep the cord away from heat, oil and sharp edges.
- **Secure the work.** Use clamps or a vice to hold the work. It is safer than using a hand and it frees both hands to operate the tool.
- **Do not overreach.** Keep proper footing and balance at all times.

- **Maintain the tool with care.** Keep a cutting tool sharp and clean for better and safer performance. Follow the instructions for lubricating and changing accessories. Inspect the tools cord periodically and, if damaged, have repaired by an authorised service facility. Inspect the extension cord periodically and replace if damaged. Keep the handles dry, clean and free from oil and grease.
- **Disconnect the tool** when not in use, before servicing and when changing accessories such as blades, bits and cutters.
- **Remove adjusting keys and wrenches.** Form the habit of checking to see that keys and adjusting wrenches are removed from the tool and replaced in the storage area before switching on.
- **Avoid unintentional starting.** Do not carry a plugged-in tool with a finger on the switch. Ensure the switch is off when plugging in.
- **Use an outdoor extension cord.** When a tool is used outdoors, only use an extension cord intended for outdoor use and so marked.
- **Stay alert.** Watch what you are doing, use common sense and do not operate the tool when tired.
- **Check damaged parts.** Before further use of the tool, a guard or other part that is damaged should be carefully checked to determine whether it will operate properly and perform its intended function. Check for alignment of moving parts, free running of moving parts, breakage of parts, mounting and any other conditions that may affect its operation. A guard or other part that is damaged should be properly repaired or replaced by an authorised service centre unless otherwise indicated in the product booklet. Have defective switches replaced by an authorised service centre. Do not use the tool if the switch does not turn it on and off.
- **Warning!** The use of any accessory or attachment, other than recommended in the product booklet, may present a risk of personal injury.
- **Have the tool repaired by a qualified person.** The electrical tool is in accordance with the relevant safety requirements. Repairs should only be carried out by qualified persons using original spare parts, otherwise, this may result in considerable danger to the user.

Save these instructions!

DOUBLE INSULATION



The tool is double insulated. This means that all the external metal parts are electrically insulated

from the mains power supply. This is done by placing insulation barriers between the electrical and mechanical components making it unnecessary for the tool to be earthed.

Note: Double insulation does not take the place of normal safety precautions when operating the tool. The insulation system is for added protection against injury resulting from a possible electrical insulation failure within the tool.

ELECTRICAL SAFETY

Be sure the supply is the same as the voltage given on the rating plate. The tool is fitted with a two-core cable and plug.

MAINS PLUG REPLACEMENT (UK ONLY)

Should the mains plug need replacing and you are competent to do this, proceed as instructed below.

If you are in doubt, contact a Black & Decker service centre or a qualified electrician.

- Disconnect the plug from the power supply.
- Cut off the plug and dispose of safely. A plug with bared copper conductors is very dangerous if engaged in a live socket outlet.
- Only fit BS1363A approved plugs fitted with the correctly rated fuse.

Note: Fuses do not give personal protection against electric shock.

- The cable wire colours, or a letter, will be marked at the connection point of most good quality plugs.

Attach the wires to their respective points in the plug (see diagram). Brown is L (live) and blue is N (neutral).

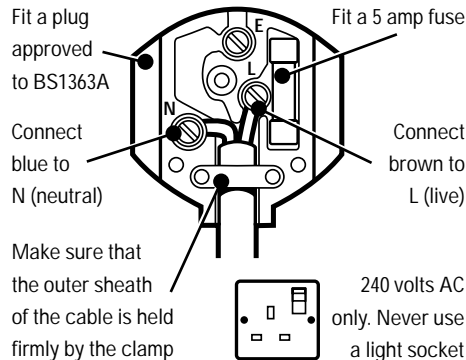

- Before replacing the top cover of the plug ensure that the cable restraint is holding the outer sheath of the cable firmly and that the two leads are correctly

fixed at the terminal screws. If the fuse cover is missing or damaged do not use the plug. For replacement or detachable fuse covers, contact a Black & Decker service centre.

Warning! Never connect live or neutral wires to the earth pin marked E or \perp .

MAINS PLUG REPLACEMENT (AUSTRALIA AND NEW ZEALAND ONLY)

Should the mains plug or cordset of the product be damaged, it must only be replaced by an authorised Black & Decker service agent because special purpose tools are required.

EXTENSION CABLES

Up to 30m (100ft) of Black & Decker 2-core extension cable (or 3-core extension cordset, in Australia and New Zealand) can be used without undue loss of power.

Note: An extension cable should not be used unless absolutely necessary. Use of an improper extension cable could result in a risk of fire and electric shock. If an extension cable must be used, make sure it is properly wired, contains the correct rated fuse as recommended in its literature and is in good electrical condition.

UNWANTED TOOLS AND THE ENVIRONMENT

 Should you find one day that the tool needs replacement or is of no further use, think of the protection of the environment. Black & Decker service centres will accept old tools and will dispose of them in an environmentally safe way.

THE BLACK & DECKER GUARANTEE (UK, AUSTRALIA AND NEW ZEALAND ONLY)

If the Black & Decker product becomes defective due to faulty materials and workmanship, within 24 months from the date of purchase, we guarantee to either replace all defective parts or at our discretion, replace the unit free of charge provided that:

- The product is returned to us or our authorised repairers with evidence of date of purchase.
- The product has not been used for trade, professional or hire purposes.
- The product has not been subjected to misuse or neglect.
- The product has not sustained any damage through foreign objects, substances or accidents.
- Repairs have not been attempted by anyone other than our own service staff or authorised repair distributors.

ENGLISH

This guarantee is offered as an extra benefit and is additional to the customers statutory rights.

AFTER SALES SERVICE FOR THE BLACK & DECKER PRODUCT (UK, AUSTRALIA AND NEW ZEALAND ONLY)

Black & Decker offers a nationwide after sales service through our company operated service centres and concessionaries on the Channel Islands and Isle of Man. It is our aim to offer excellent service, fast repairs, extensive parts availability and full accessory support. The use of other than genuine Black & Decker accessories and parts may damage or reduce the performance of your Black & Decker product and may also endanger the user. The terms and conditions of the warranty may also be effected.

THE AFTER SALES SERVICE POLICY (UK, AUSTRALIA AND NEW ZEALAND ONLY)

It is our aim that all Black & Decker customers should be totally satisfied with their Black & Decker product and after sales service, but if help or advice is needed please contact the local Black & Decker service centre manager who will be happy to help. Full details of our unique after sales service can be obtained from any of our Black & Decker service centres.

ACCESSORIES

The performance of any power tool is dependant upon the accessory used. Black & Decker accessories are engineered to high quality standards and are designed to enhance the performance of your tool. Buying a Black & Decker accessory will ensure that you get the very best from your Black & Decker tool.

TECHNICAL DATA

The level of sound pressure of the tool is in accordance with EEC legislation. It is recommended that you take appropriate measures for the protection of your hearing if the sound level seems uncomfortable. This normally equates to a sound pressure in excess of 85dB (A).

Note: This user manual also covers catalogue numbers ending with a letter suffix. Refer to your carton for details of your product.

FEATURES

1. On/off switch
2. Speed control
3. Lock-on button
4. Side handle
5. Chuck jaws
6. Chuck
7. Hammer/drill switch
8. Forward/reverse switch
9. Adjustable depth stop

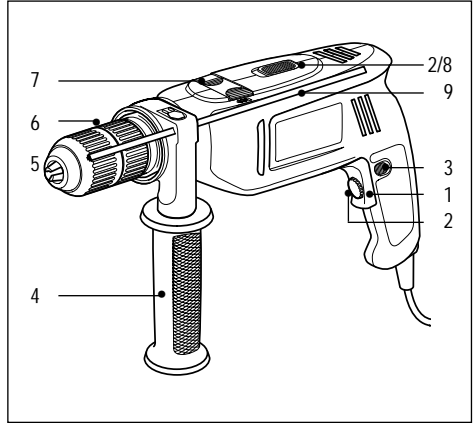

Your drill includes some or all of these features:

- The on/off switch is used to operate your drill in all modes of operation.
- The variable speed control provides optimal control of your drill for a wide range of tasks.
- On two-speed drills, the speed switch permits selection of the appropriate drilling speed.
- The lock-on button provides continuous operation of your drill.
- The side handle gives a secondary gripping position for your drill.
- Your drill can operate as a hammer drill or a rotary drill depending on the setting of the hammer/drill switch.
- The forward/reverse switch controls the direction of rotation when your drill is used as a screwdriver, or when clearing a jammed drill bit.
- The adjustable depth stop gives precise control of the hole depth, when you drill blind holes.

FITTING THE DRILL BIT (KEYLESS CHUCKS)

Proceed as follows:

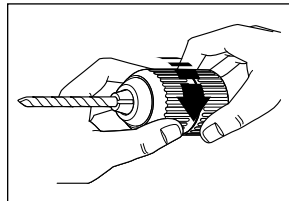

Disconnect the plug from the electricity supply. While holding the rear section of the chuck, rotate the front section until the jaws of

the chuck are sufficiently open. Insert the drill bit in the jaws of the chuck. Hold the rear section of the chuck while tightening the front section. Twist the two sections firmly in opposite directions to securely grip the drill bit.

FITTING THE DRILL BIT (KEYED CHUCKS)

Proceed as follows:

Disconnect the plug from the electricity supply.

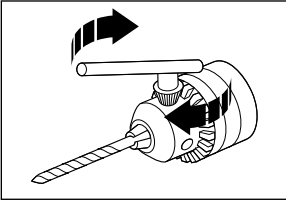

Rotate the barrel of the chuck until the jaws are sufficiently open. Insert the drill bit in the jaws of the chuck. Insert the chuck key with

the end of the chuck key in one of the three holes in the body of the chuck and the head of the chuck key engaged with the barrel of the chuck. Turn the chuck key clockwise to tighten the jaws and securely grip the drill bit. Remove the chuck key.

REMOVING THE CHUCK (KEYLESS CHUCKS)

Proceed as follows:

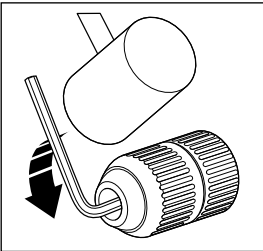

To remove the chuck, open the jaws, hold it firmly in one hand and with a screwdriver held in the other hand, turn the set-screw in the chuck clockwise approximately one turn, to loosen it.

Place an allen key in the chuck and tighten the jaws. Give the allen key a short powerful blow in an anti-clockwise direction with a hammer to loosen the chuck on the spindle. Remove the allen key. Use the screwdriver to turn the set-screw clockwise until it totally disengages from the spindle. Remove the chuck from the spindle by rotating it anti-clockwise. To fasten the chuck, put it on the thread and turn it clockwise until it stops. Put in the screw and turn it anti-clockwise until absolutely firm.

REMOVING THE CHUCK (KEYED CHUCKS)

Proceed as follows:

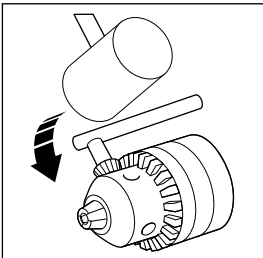

To remove the chuck, open the jaws of the chuck with the chuck key. Hold the chuck firmly in one hand, and with a screwdriver turn the screw set in the chuck clockwise with the other hand until it comes out.

Use only the correct chuck key. Place the chuck key into the chuck, and hold the drill firmly in one hand with the chuck pointing away from you. Rotate the chuck so that the chuck key is just above the horizontal position on the right hand side of the machine. Give the crossbar end of the key a sharp downward blow with a mallet or light hammer. The chuck should now be sufficiently loose to be unscrewed by hand.

FITTING THE SIDE HANDLE

Proceed as follows:

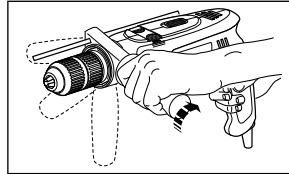

Position the side handle on the body of your drill. Rotate the handle around the body of your drill until it is in the desired

position. Tighten the handle by turning clockwise.

SETTING THE ADJUSTABLE DEPTH STOP

Proceed as follows:

Fit the drill bit. Loosen the side handle.

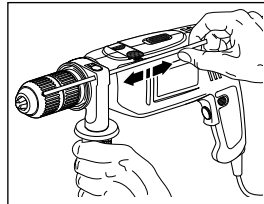

Slide the depth stop until the end of the depth stop aligns with the end of the drill bit. Slide the depth stop until the distance between the end of the depth

stop and the end of the drill bit is equal to the length of the screw you will fit. Tighten the side handle.

PREPARING YOUR DRILL FOR OPERATION

Proceed as follows:

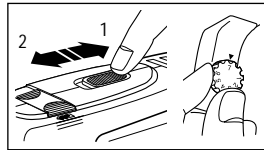

Fit the correct accessory for the job. Set the depth stop if required. Set the speed of your drill.

On two-speed drills, set the two-speed switch to '1' (low-speed) or '2' (high-speed), or set the variable speed control to the desired speed. As a general rule, for large size drill bits use low speeds and for smaller drill bits use high speeds.

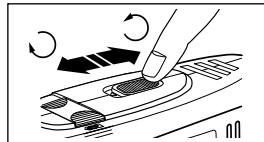

On two-speed drills, set the two-speed switch to '1' (low-speed) or '2' (high-speed), or set the variable speed control to the desired speed. As a general rule, for large size drill bits use low speeds and for smaller drill bits use high speeds. Set the forward/reverse switch to the desired direction of rotation. Never change the setting of the hammer switch,

ENGLISH

the speed switch or the forward/reverse when your drill is operating.

USING YOUR DRILL

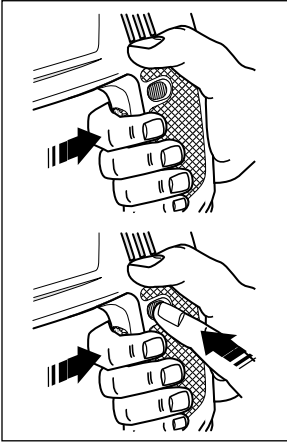

To switch your drill on, depress the on/off switch. Your drill stops when the on/off switch is released. If continuous operation is required, depress the lock-on button while the on/off switch is depressed. To stop your drill when operation is continuous, depress the on/off switch

again and release. While your drill is in operation, do not touch the chuck.

HANDY HINTS

- Fit the correct size and type of drill or screwdriver bit.
- Set the correct drill speed.
- Always hold your drill using the handle and the side handle.
- Always hold your drill at right-angles to your work.

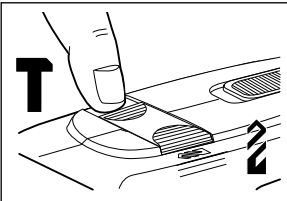

When drilling wood and metal, set the hammer switch to the drill mode. When drilling masonry, set the hammer switch

to the hammer mode. When screwdriving, set the hammer switch to the drill mode.

- Set the forward/reverse switch to the correct direction.
- Never change the direction of rotation when your drill is in operation.
- After use, remove the drill bit and gently tap the side of the chuck with a soft-faced hammer to remove the dust. This will extend the life of the chuck.

COOLING DOWN

If your drill becomes too hot in use, set the speed control to its highest setting and allow your drill to operate without load for 2 minutes.

OVERLOAD

Never use excessive force when using your drill. Too much pressure can reduce the speed of your drill and reduce its efficiency. This can result in an overload which can cause damage to the motor of your drill.

EC DECLARATION OF CONFORMITY

We declare that units: **KD350RE, KD351RE, KD352, KD353, KD354E, KD355RE, KD355CRE, KD356CRE, KD455CRE** conform to 89/392/EEC, 89/336/EEC, EN55014, 73/23/EEC, EN55104, EN50144
A weighted sound pressure 100dB (A)
A weighted sound power 113dB (A)
Hand/arm weighted vibration 8.7m/s²

Brian Cooke - Director of Engineering
Black & Decker Ltd, Spennymoor, County Durham
DL16 6JG United Kingdom

The Black & Decker policy is one of continuous improvement to our product and as such we reserve the right to change the product specification without prior notice.

Australia	Black & Decker (Asia) Pty Ltd 286-288 Maroondah Highway North Croydon, Victoria 3136	Tel: 03 9213 8200 Fax: 03 9726 7150
New Zealand	Black & Decker 483 Great South Road, Penrose, Auckland	Tel: 09 579 7600 Fax: 09 579 8200
South Africa	Powerdek Tool Distributors 22 Inglestone Road, Village Deep Johannesburg, South Africa	Tel: 011 493 4000 Fax: 011 493 6391
United Kingdom	Black & Decker 210 Bath Road Slough Berkshire SL1 3YD	Tel: 0345 230230 Tel: 01753 511234 Tlx: 848317 BAND MH Fax: 01753 551155

Address of the dealer where your corded drill was purchased:

Date of your purchase:

Name: _____

House number or name and street: _____

Town: _____

County or state: _____

Postcode: _____

Country: _____

Product catalogue number: **KD**_____ / _____

Data protection act: Tick this box if you prefer **not** to receive information from Black & Decker or other companies.

Yes

No

Was your corded drill a gift?

Was your corded drill your first purchase?

Was your corded drill bought as a replacement?

What was the price of your corded drill? _____

Address of the dealer where your corded drill was purchased:

GUARANTEE CARD

Australia: Call 1 900 937766 (the maximum call charge is \$2.00 excluding tax)

New Zealand: Call 0900 97766 (the maximum call charge is \$2.00 excluding tax)

South Africa: After sales service, PO Box 5303, Johannesburg 2000

United Kingdom & Ireland: PO Box 821, Slough, Berkshire, SL1 3AR



Please cut out this section, put into a stamped addressed envelope and post immediately after the purchase of your corded drill to the Black & Decker address in your country (above).

If you live in Australia or New Zealand, please register your purchase by phone.