



Black & Decker

WORKMATE®

Portable Work Center with Vise

\$

**OWNER'S
MANUAL**

Model 79-001



**AS SEEN
ON TV**

DUAL 29" MODEL

◀ 31⁷/₈" Workbench Height
23¹/₄" Sawhorse Height ▶

All Steel Frame
Strong yet light in weight.

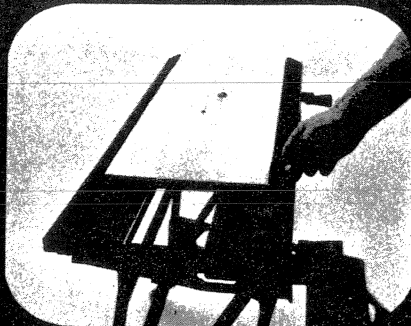
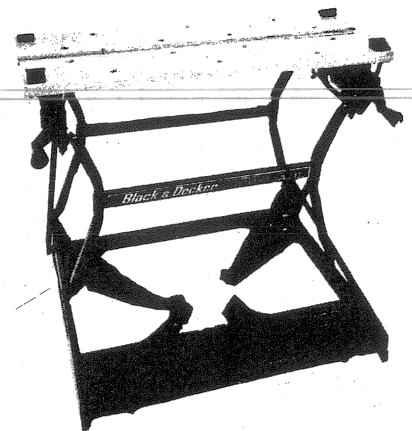

Holds lumber up to 12 inches wide. Ideal for shelving.



V-grooves hold pipe and tubing up to 5¹/₄" wide.



Independent vise jaws allow clamping of irregularly shaped or tapered objects: bikes, furniture, doors, shutters, etc.



4 swivel grips hold odd shaped items securely for sanding, sawing, routing.



Vise jaws hold mitre box securely for precise cuts.

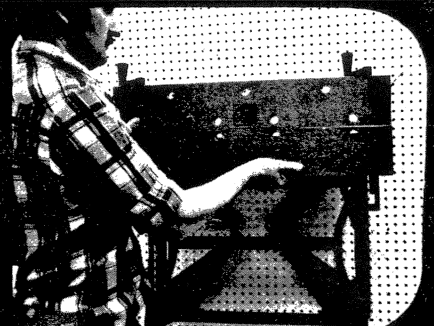

WORKMATE® Work Center is light-weight, portable and compact for easy storage.

Setting up WORKMATE® portable work center and vise.

The Work Center sets up easily into two working heights: the lower "saw horse" height and the upper "workbench" height. Choose the position best suited to your particular job. In each case, The Work Center provides a convenient and rigid work surface.

Remainder of Work Center omitted for clarity.

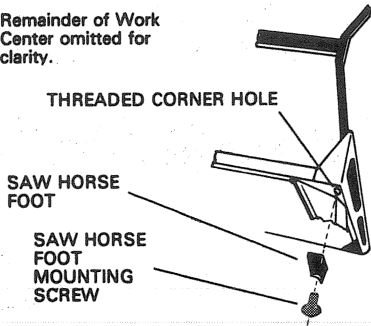

Lower Sawhorse Feet

1. The Lower Sawhorse feet & screws are shipped in a plastic bag along with the two snap-in handles and 4 swivel grips.

Assemble the four (4) saw horse feet using the mounting screws provided as shown in illustration #1.

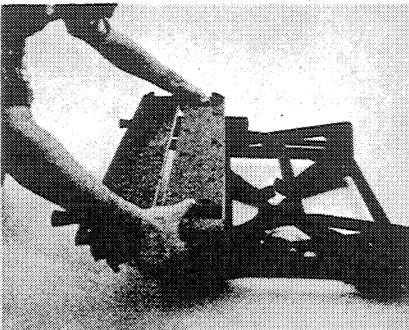

2. Place the WORKMATE® Portable Work Center and Vise on the floor as illustrated. Press the release buttons located on either side (as shown) and lift the unit until it locks into position.

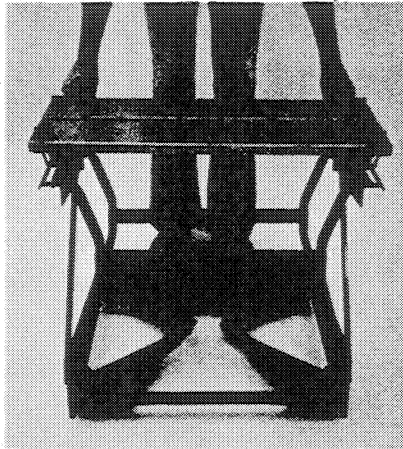

3. This is the lower "sawhorse" height, measuring 23 1/4" high. Be sure The Work Center locks into position.



4. To raise The Work Center to its full "workbench" height of 32 1/4", extend the 4 base legs as shown.



5. Always make sure that each leg is swung into its extended position. This will ensure safe use of The Work Center at this upper working height.

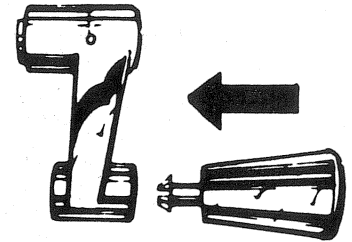

6. Snap handle knobs into handle arms on the vise bracket

Safety Rules

1. Do not load with more than 350 lbs.
2. Do not apply unbalanced load which could cause The Work Center to tip.
3. Do not use lower platform as a step when The Work Center is in "workbench" position.
4. Do not use The Work Center as a stepladder or standing platform.
5. Do not store The Work Center outdoors or in damp areas.
6. Avoid applying excessive force when clamping in only lower half of the vise jaws or when using the swivel grips.
7. Be sure that table locks in "sawhorse" position and that legs extend to the "workbench" position.
8. When using a power tool with The Work Center, follow the Safety Rules in the tool's Instruction Manual.
9. Wear safety glasses when using power tools.
10. See "Using Power Equipment" (page 6) for correct method of securing power tools in The Work Center. Never mount power tools in vise; pressure may damage tools.
11. An even pressure of jaws on workpiece is essential. Tighten both jaw handles uniformly.

Maintenance Tips

1. Pivot screws are of low friction design. No lubrication is necessary.
2. If binding of vise jaw occurs, cleaning or lubrication of slider and vise screw may be required.
3. Pivot screws should be checked for tightness.

How to store your WORKMATE® portable work center and vise

1. Store swivel grips upside down in table top until next application.
2. Fold in all four base legs and clamp in locked position.
3. Place one foot on step.
4. Using thumbs, simultaneously pull both retainer latches toward you.
5. Pull unit straight up until latch releases.
6. Close unit and clamp in locked position.
7. You can now store WORKMATE conveniently in minimum space.

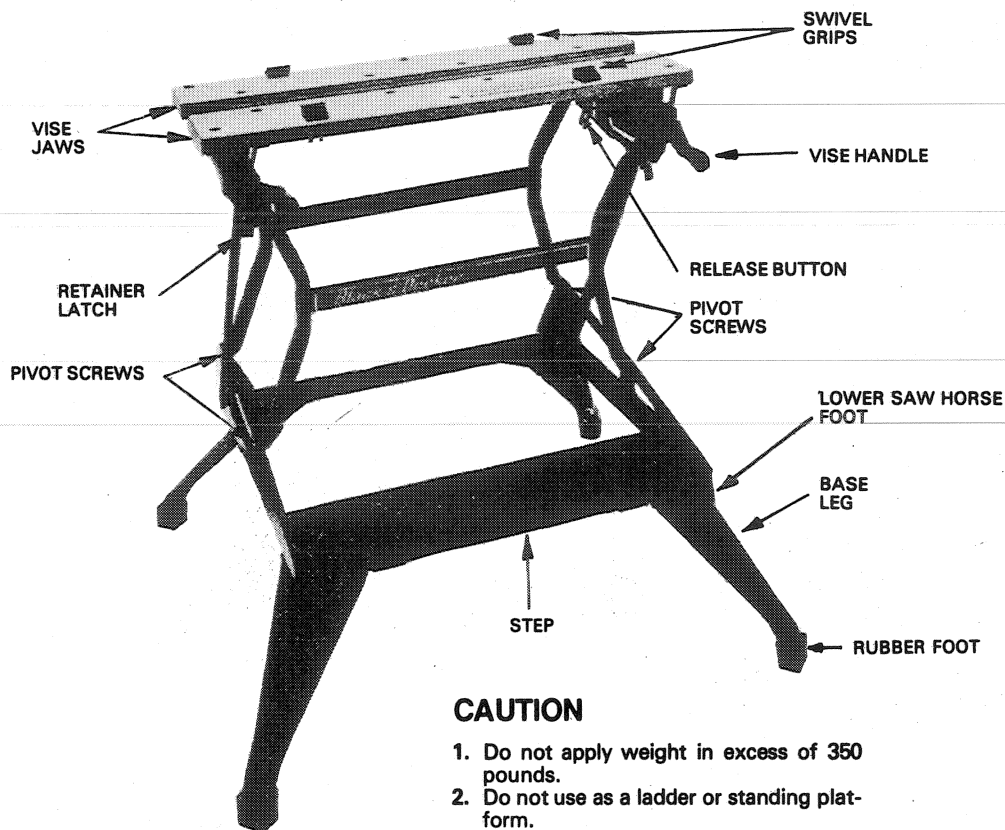
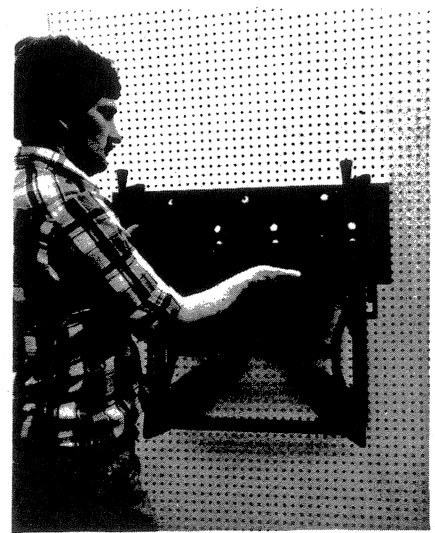
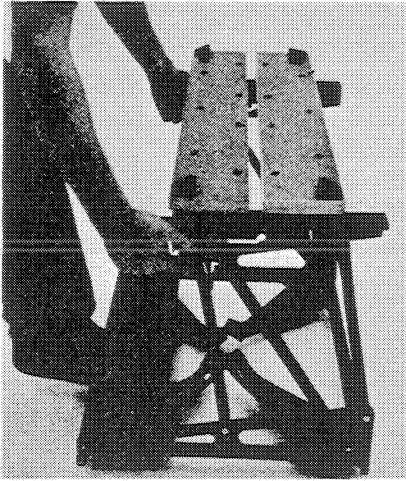

CAUTION

1. Do not apply weight in excess of 350 pounds.
2. Do not use as a ladder or standing platform.

Working with your WORKMATE® portable work center and vise

The Work Center is a vise, sawhorse and workbench all in one. Its basic design and special features help you to perform a complete range of workshop tasks from the simplest to the most complicated.

The heart of The Work Center is in the action of the two parallel vise jaws.

The two vise handles adjust the jaws to a maximum of 5 1/4" jaw opening. Because each handle works independently, the opening can be tapered from 0" to 5 1/4" maximum.

Use of the swivel grips in the appropriate vise holes extends the vise capacity of The Work Center up to 12" wide, or up to 21" when objects are held diagonally.

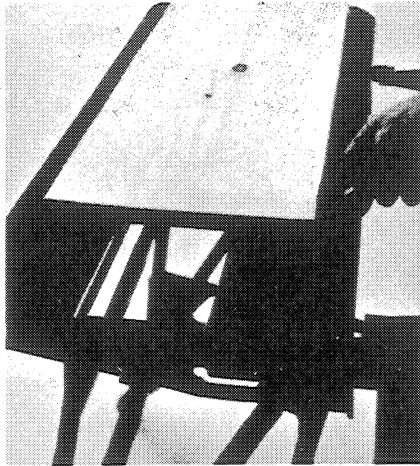

3. Using the swivel grips to extend the vise capacity.

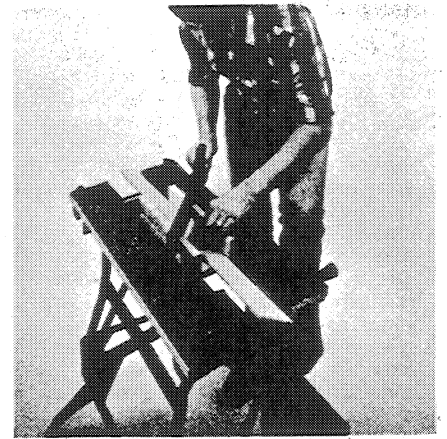

6. Holds a mitre box for more accurate angle cuts. Note: Place foot on Work Center step for added rigidity.



1. Adjusting the vise jaws with the vise handles.

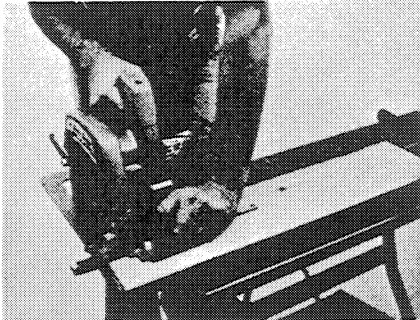

4. Holds material securely.

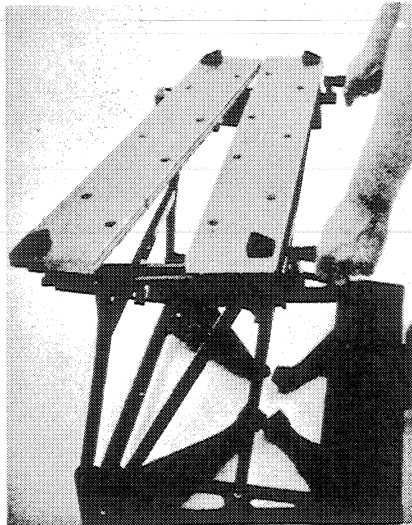

2. Tapering the vise opening, using the independently operated vise handles.

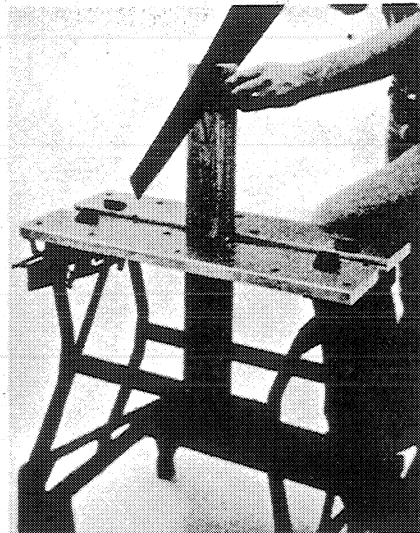

5. Grips hard to hold objects while sawing.

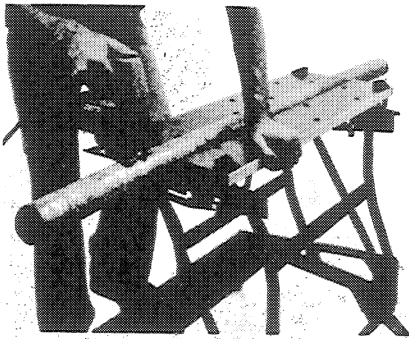

7. Sawing tubular pieces is easy when they are held horizontally in the specially designed V-grooves running along the face of the vise jaws.

PLANING, SANDING, ROUTING

WORKMATE® Portable Work Center and Vise permits you to do a better job when planing, sanding, and routing because work is held securely.

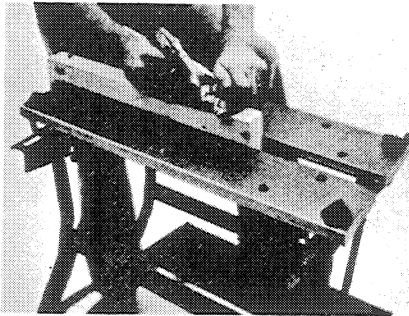

9. Holds material at perfect height and position.

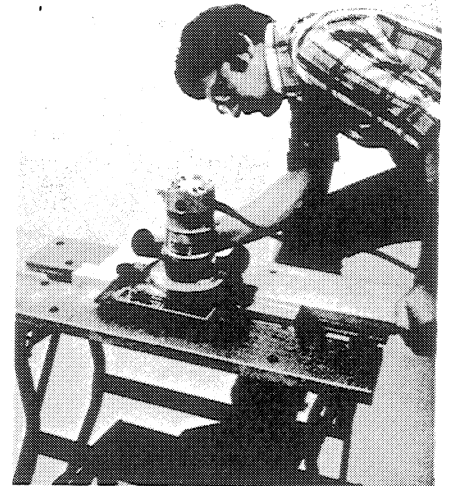

12. Special tasks won't mean special problems anymore. Routing can be easy and the results more professional.

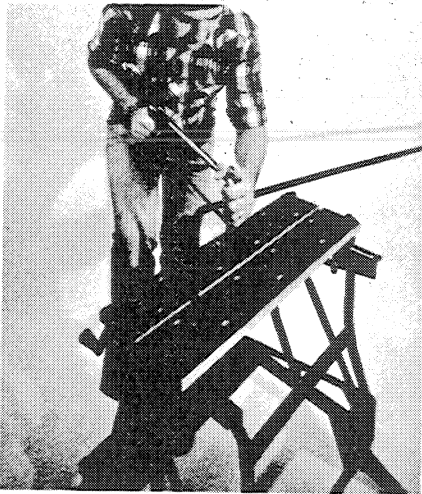

8. Vertical V-grooves in the face of the vise jaws permit rigid vertical grasping of tubular objects.

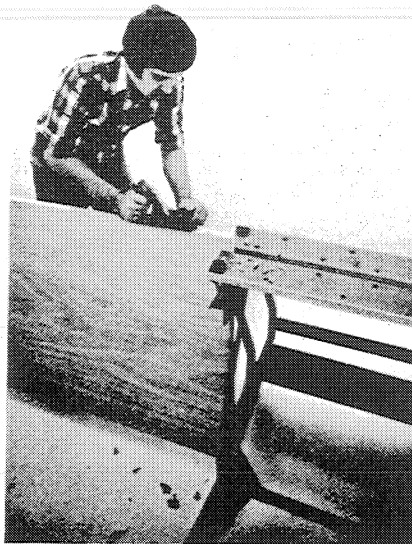

10. Strength and stability to handle large and awkward sizes and shapes.

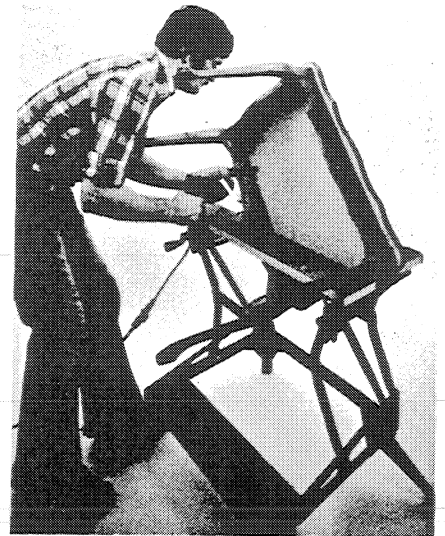

13. **WORKMATE® Portable Work Center and Vise** brings the job up to where you can reach and see it, even with hard-to-hold items.

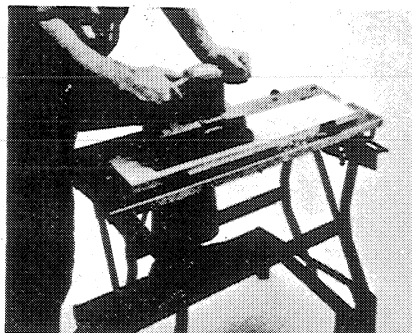

11. Power sand the most irregular shapes. Swivel grips hold material securely.

Using power equipment with WORKMATE® portable work center and vise

Construct individual mounting boards for your power tools to save workbench space. Makes your power tools completely portable when placed in The Work Center.

Caution:

1. Securely mount tool accessories to mounting board with screws or bolts.
2. Always wear safety glasses when using power tools with The Work Center.

Power Tool Mounting Board

1. Attachments such as Black and Decker Vertical Drill Stand and the Horizontal Drill Stand may be attached with screws to a suitable sized piece of plywood, to the underside of which a block of wood is attached. The block, when gripped securely in the Work Center vise jaws, provides rigidity for the operation of the tools in the attachments.

Suggested Sizes

- A. Mounting Board 12"x12"x3/8".
- B. Vise Block 2"x4"x6".
- C. Retaining Board 3"x3"x1/4".
- D. Bolt 5".

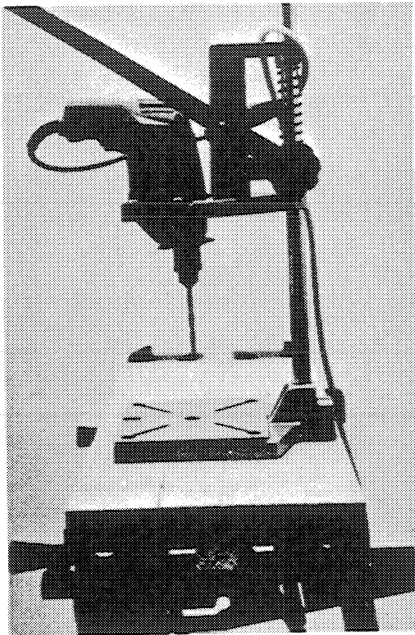
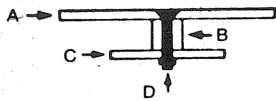

2. The block of wood on the underside of the mounting board is held in the jaws of The Work Center. The power tool is secure for use.



3. Set at "workbench" height, The Work Center is a perfect mount for cleaning rusty tools and equipment.



6. Add power tools you thought you never had room for. Securely holds even the larger tools.

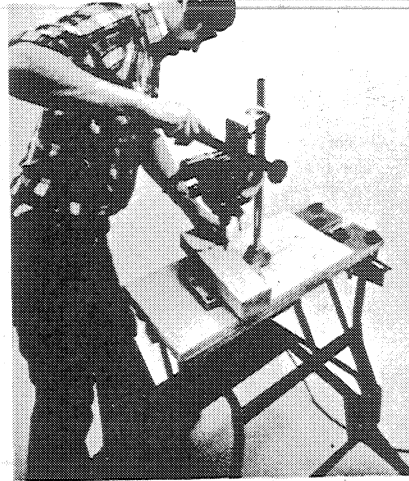

4. Your power drill and drill press can go along with you on any job, across town or into the next room.

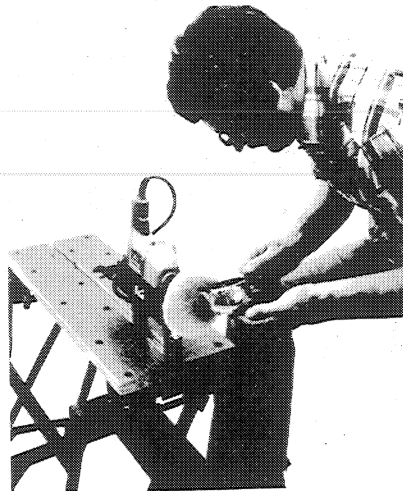

5. You'll want to use all of your power tool accessories more often. For instance, buffing. It's easier and more convenient with The WORKMATE® Work Center.

Holding Irregular Shapes with WORKMATE® portable work center and vise

Using the swivel grips in the appropriate holes and the independent action of both vise handles, The Work Center can secure the most irregular shapes. Lets you grip objects that used to be impossible to hold.

Rotate swivel grips to accept irregular shapes. Outside swivel grips extend vise capacity for a 21" diagonal grip.

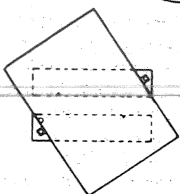
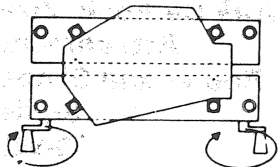

2. The WORKMATE® Work Center makes jobs easier by giving you an extra pair of hands when you really need them. Holds the most ungainly shapes securely.



5. Because each end of the vise works independently of the other, tapered objects can be held securely.

General Purpose Table

Suggested Sizes:
2'x6' x 1/4" plywood
2'x4" stud, 30" long
4 bolts 5" long

Caution:

1. Do not use nails or screws. Use bolts.
2. Center table top over center of vise jaws.

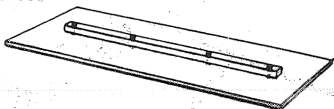

3. Jobs get done right the first time, and with less frustration, when the swivel grips take hold of the problem.



6. If you have a hobby that requires a steady work surface, The WORKMATE® Work Center provides it. It's the vise and work center that lets you get at your project from any angle.

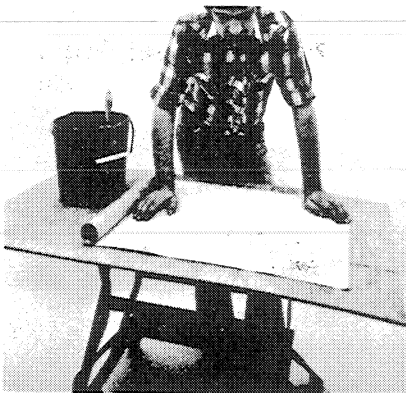

1. When the project calls for extra work space, you can make a work table by attaching a block of wood to the underside of a piece of plywood. Makes an extra long table surface for a work or play occasion. Center table over center of vise jaws.

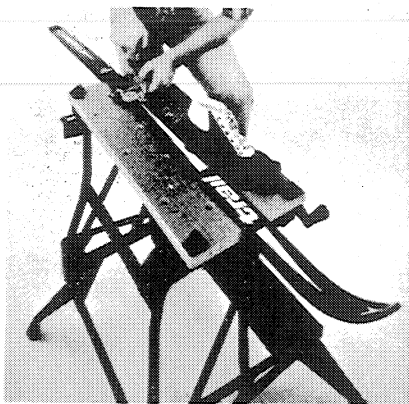

4. It's hard to find a shape that can't be held securely, and the object is always at the proper height to work on.



Black & Decker

WORKMATE® WORK CENTER & VISE ACCESSORIES

WORKMATE® Work Center & Vise Attachment Clamp—79-011

An easily operated tool that clamps parts for gluing, holds items for sawing, drilling, sanding, routing on a horizontal surface. Fits into holes on WORKMATE vise jaws or any other work surface with 3/4" hole. Adjustable to heights up to 3 3/4". Can be rotated 360°. Has up to 100 lbs. clamping force. Does not mar work surface.

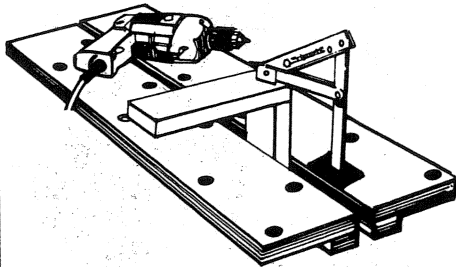

WORKMATE® Work Center & Vise Attachment Mitre and Saw Guide 79-012

Designed for work with WORKMATE and any 7 1/4" circular saw with maximum shoe length of 15". (Can't be used with 79-020 Bench Top WORKMATE®). Provides greater degree of accuracy. Use for cutting rafters, floor joists, studs, window and base trim, aluminum siding. Mitres from 30° to 90° in 5° increments. Permits sawing at 90° with maximum board width of 17". Allows sawing at 30°, 7 3/4" maximum board width; using MITREMATE in opposite direction, maximum board width is 4". Maximum board thickness: 2 7/8". Cutting depth: 90° 1 5/8", 45° 1 5/16".

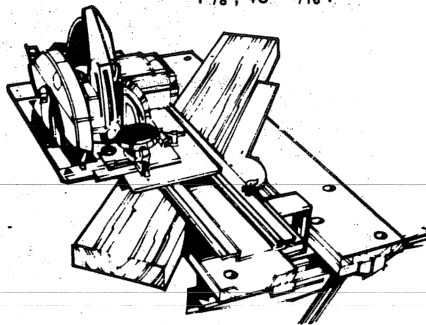

WORKMATE® Work Center & Vise Attachment Router and Shape Guide 79-013

Designed to be used with most routers to perform shaping and routing on WORKMATE. Use with all Black & Decker routers. Use for routing edges, beading, free hand routing of fancy designs, etc. Work is guided by fence, router is rigidly held. Adjustable width and depth. Maximum wood thickness 1 5/8". Maximum diameter of cutter 1". Makes routing easier.

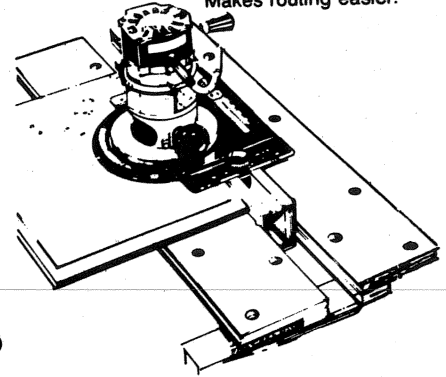

HOME USE WARRANTY

(A Full One Year Warranty)

Black & Decker warrants this product for one year. We will repair, without charge, any defects due to faulty material or workmanship or at our option replace the product free. Please return the complete unit, transportation prepaid, to any Black & Decker Service Center or Authorized Service Station listed under "Tools Electric" in the yellow pages. This warranty does not apply to accessories. This warranty gives you specific legal rights and you may have other rights which vary from state to state. Should you have any questions, contact your nearest Black & Decker Service Center Manager.

79-010 Swivel Grips (2)

For additional versatility in holding objects or to replace lost grips.

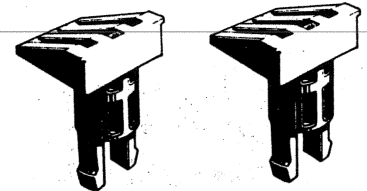

we're in



See "Tools Electric" for Service & Sales.

yellow pages

® & TM: Trademarks of The Black and Decker Manufacturing Company

Black & Decker (U.S.) Inc., Towson, Maryland 21204

Form 976446-02

Printed in Canada